

# STANDEN

## OMEGA Separator Units

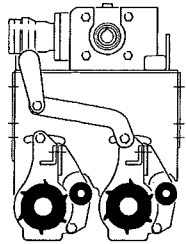

2 Scroll Shafts

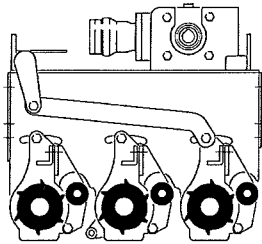

3 Scroll Shafts

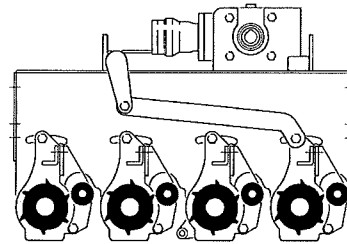

4 Scroll Shafts

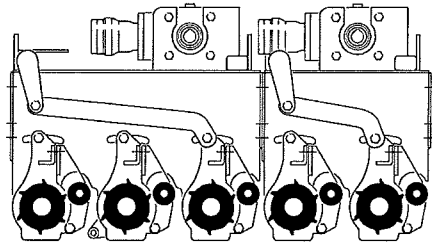

5 Scroll Shafts (3+2)

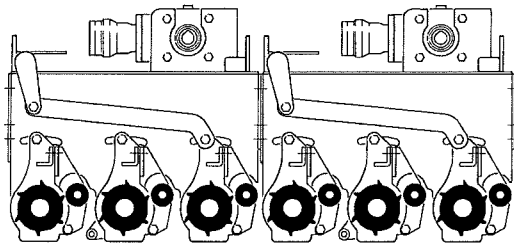

6 Scroll Shafts (3+3)

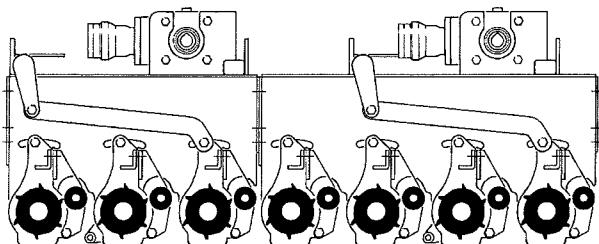

7 Scroll Shafts (3+4)

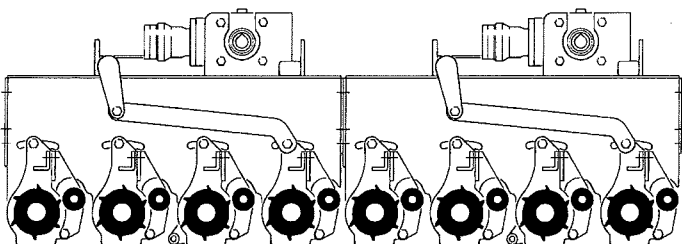

8 Scroll Shafts (4+4)

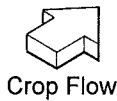
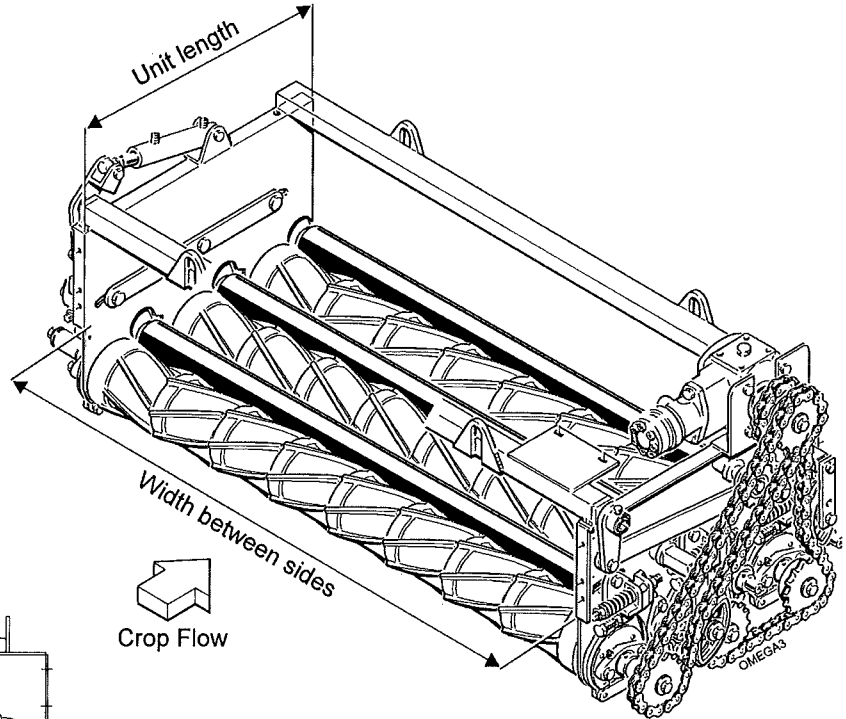

Crop Flow

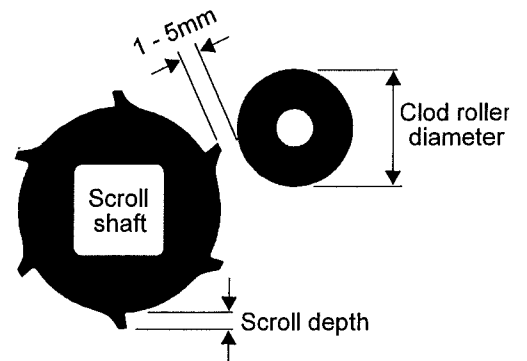

Standen Engineering Limited. Hereward Works, Station Road, Ely, Cambridgeshire. CB7 4BP  
England.

Tel: 01353 661111

www.standen.co.uk

Fax: 01353 662370

# Standen Engineering Limited

## Omega Separator

|                             |        |        |        |        |        |        |        |        |        |        |        |
|-----------------------------|--------|--------|--------|--------|--------|--------|--------|--------|--------|--------|--------|
| No of Scroll Shafts (Units) | 2      | 3      | 4      | 5(3+2) | 6(3+3) | 7(3+4) | 8(4+4) |        |        |        |        |
| Unit Length                 | 474mm  | 711mm  | 949mm  | 1185mm | 1422mm | 1660mm | 1898mm |        |        |        |        |
| Tick Requirement            |        |        |        |        |        |        |        |        |        |        |        |
| Width of Separator          | 1.2M   | 1.4M   | 1.6M   | 1.8M   | 2.0M   | 2.2M   | 2.4M   | 2.6M   | 2.8M   | 3.0M   | 3.2M   |
| Width between sides         | 1261mm | 1434mm | 1607mm | 1780mm | 1953mm | 2126mm | 2472mm | 2645mm | 2818mm | 2991mm | 3164mm |
| Number of Segments per Row  | 7      | 8      | 9      | 10     | 11     | 12     | 14     | 15     | 16     | 17     | 19     |
| Tick Requirement            |        |        |        |        |        |        |        |        |        |        |        |

### Scroll Segments (Height of Flutes)

|              |   |   |   |   |   |   |   |   |
|--------------|---|---|---|---|---|---|---|---|
| Shaft Number | 1 | 2 | 3 | 4 | 5 | 6 | 7 | 8 |
| 10mm         |   |   |   |   |   |   |   |   |
| 6mm          |   |   |   |   |   |   |   |   |

### Extraction Roller

|                          |   |   |   |   |   |   |   |   |
|--------------------------|---|---|---|---|---|---|---|---|
| Shaft Number             | 1 | 2 | 3 | 4 | 5 | 6 | 7 | 8 |
| 76mm Dia Steel           |   |   |   |   |   |   |   |   |
| 76mm Dia Ebonite         |   |   |   |   |   |   |   |   |
| 73mm Dia Stainless Steel |   |   |   |   |   |   |   |   |

Extraction Roller Lift Shaft - quantity must match the number of units